

SPECIFICATIONS			
SHELL WEIGHT PESO DE LA PISCINA	557,8 LBS.	253,0 Kg	
WATER WEIGHT PESO DEL AGUA	45194,7 LBS.	20500,0 Kg	
TOTAL WEIGHT PESO TOTAL	45752,5 LBS.	20753,0 Kg	
WATER VOLUME VOLUMEN DE AGUA	724,0 Cu.Ft.	20,5 m ³	
WATER GALLONS AND LITERS GALONES Y LITROS DE AGUA	5415,5 GAL.	20500,0 L	
SURFACE AREA ÁREA DE SUPERFICIE	240,9 Sq. Ft.	22,4 m ²	
ICC-ES LISTED# ICC-ES LISTADO	ESR-4370		

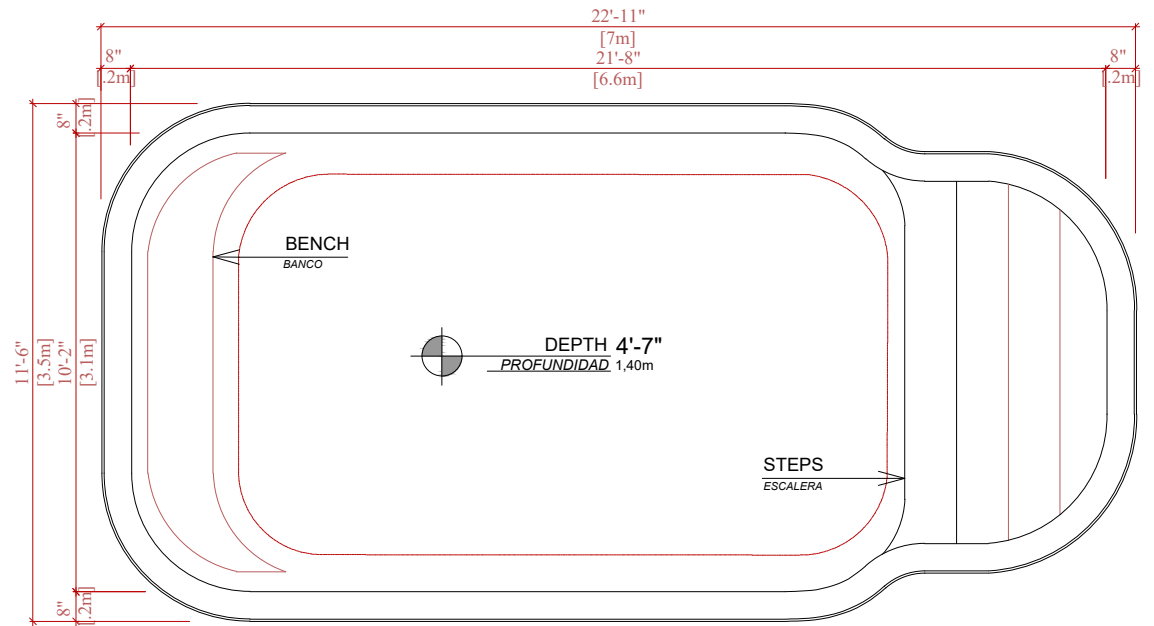

TECHNICAL DRAWING
DIBUJO TÉCNICO

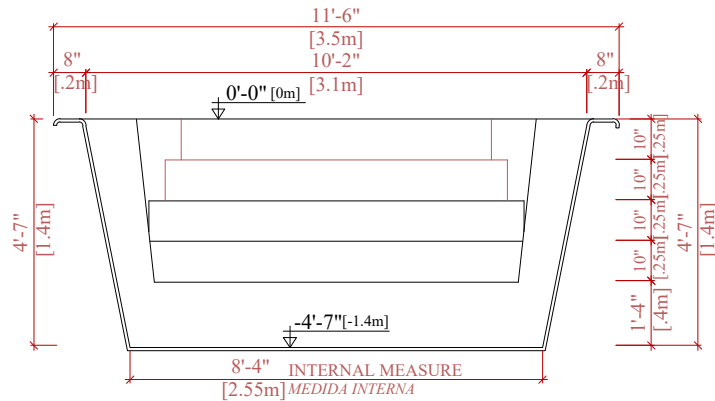

CROSS SECTION
CORTE TRANSVERSAL

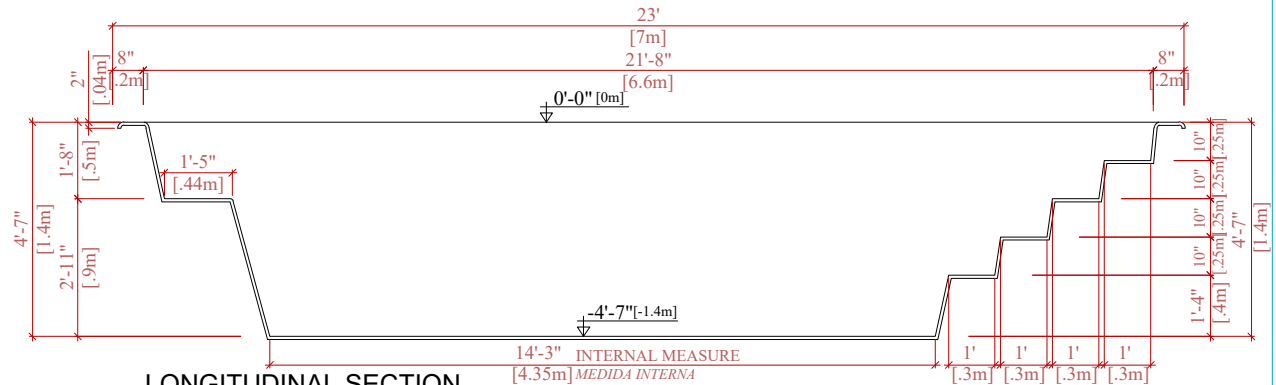

LONGITUDINAL SECTION
CORTE LONGITUDINAL