

SPECIFICATIONS		
SHELL WEIGHT PESO DE LA PISCINA	802,5 LBS.	364,0 Kg
WATER WEIGHT PESO DEL AGUA	64374,9 LBS.	29200,0 Kg
TOTAL WEIGHT PESO TOTAL	65177,4 LBS.	29564,0 Kg
WATER VOLUME VOLUMEN DE AGUA	1031,2 Cu.Ft.	29,2 m ³
WATER GALLONS AND LITERS GALONES Y LITROS DE AGUA	7713,8 GAL.	29200,0 L
SURFACE AREA ÁREA DE SUPERFICIE	343,7 Sq. Ft.	31,9 m ²
ICC-ES LISTED# ICC-ES LISTADO	ESR-4370	

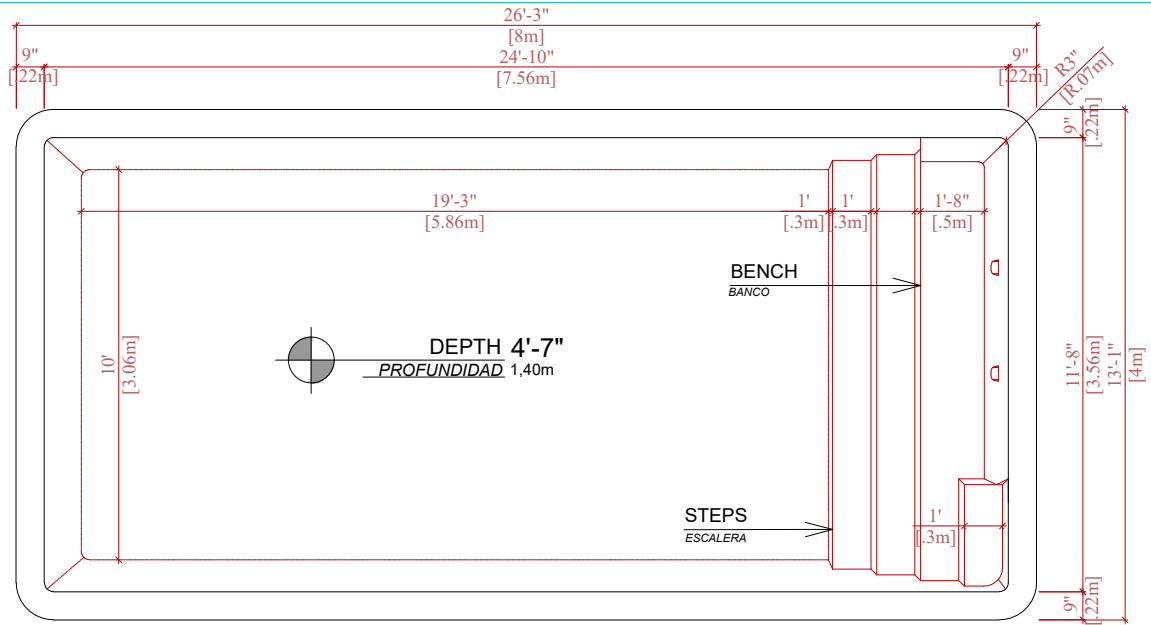

TECHNICAL DRAWING
DIBUJO TÉCNICO

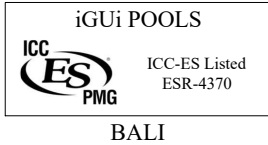
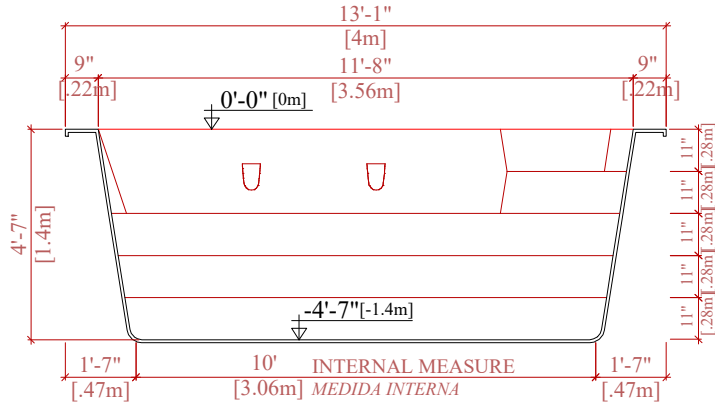

CROSS SECTION
CORTE TRANSVERSAL

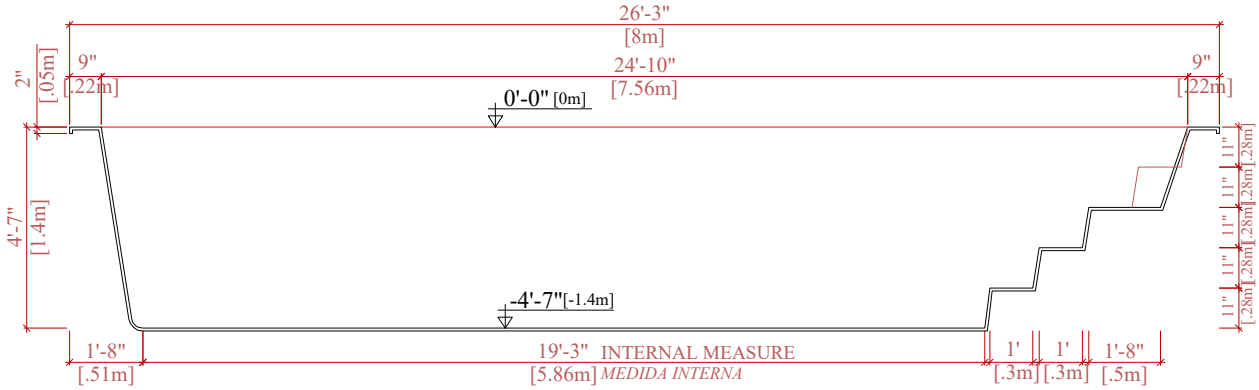

LONGITUDINAL SECTION
CORTE LONGITUDINAL