

SPECIFICATIONS		
<b>SHELL WEIGHT</b> PESO DE LA PISCINA	632,7 LBS.	287,0 Kg
<b>WATER WEIGHT</b> PESO DEL AGUA	58422,4 LBS.	26500,0 Kg
<b>TOTAL WEIGHT</b> PESO TOTAL	59055,2 LBS.	26787,0 Kg
<b>WATER VOLUME</b> VOLUMEN DE AGUA	935,8 Cu.Ft.	26,5 m <sup>3</sup>
<b>WATER GALLONS AND LITERS</b> GALONES Y LITROS DE AGUA	7000,6 GAL.	26500,0 L
<b>SURFACE AREA</b> ÁREA DE SUPERFICIE	298,7 Sq. Ft.	27,8 m <sup>2</sup>
<b>ICC-ES LISTED#</b> ICC-ES LISTADO	ESR-4370	

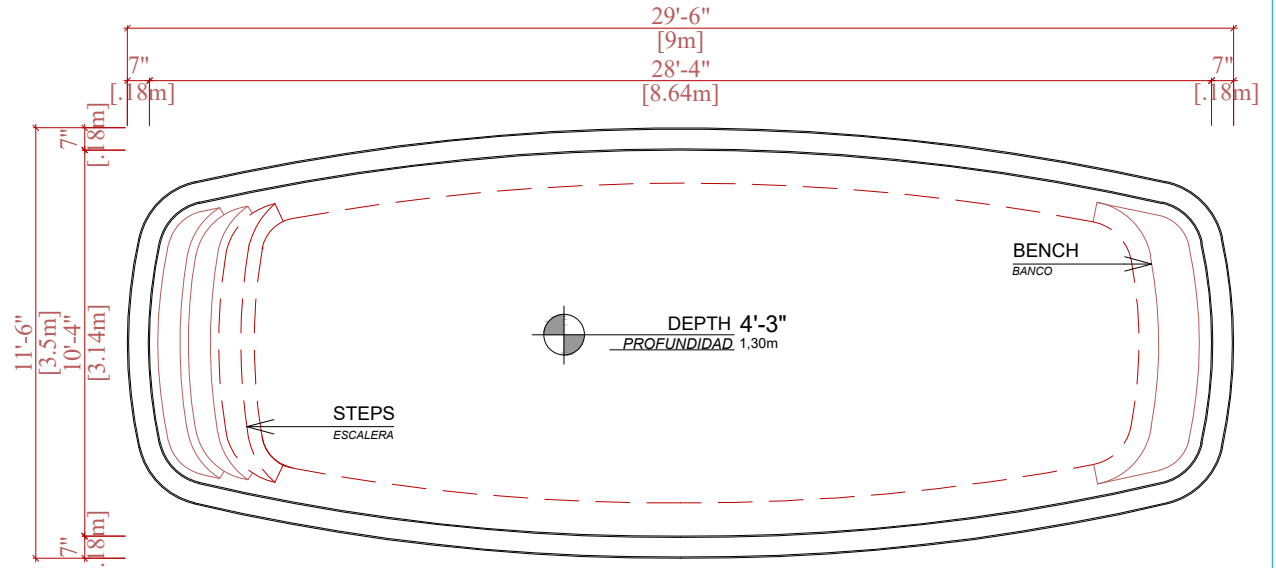

TECHNICAL DRAWING  
DIBUJO TÉCNICO

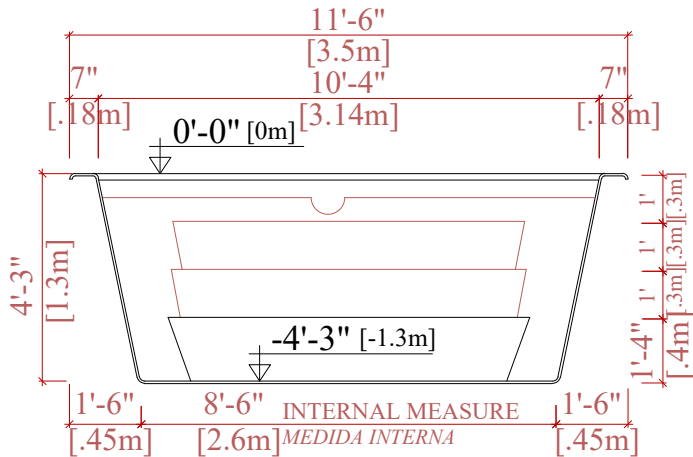

CROSS SECTION  
CORTE TRANSVERSAL

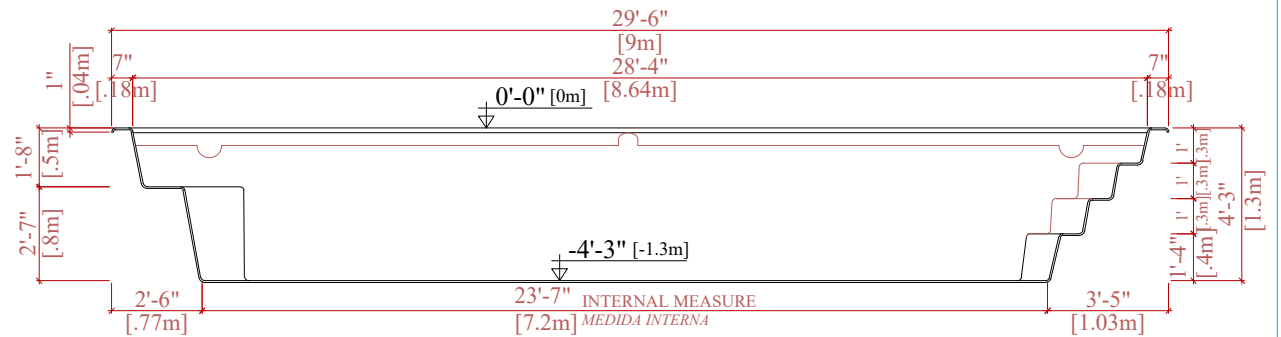

LONGITUDINAL SECTION  
CORTE LONGITUDINAL