

SPECIFICATIONS		
SHELL WEIGHT PESO DE LA PISCINA	304,2 LBS.	138,0 Kg
WATER WEIGHT PESO DEL AGUA	20282,5 LBS.	9200,0 Kg
TOTAL WEIGHT PESO TOTAL	20586,7 LBS.	9338,0 Kg
WATER VOLUME VOLUMEN DE AGUA	324,9 Cu.Ft.	9,2 m ³
WATER GALLONS AND LITERS GALONES Y LITROS DE AGUA	2430,4 GAL.	9200,0 L
SURFACE AREA ÁREA DE SUPERFICIE	150,0 Sq. Ft.	13,9 m ²
ICC-ES LISTED# ICC-ES LISTADO	ESR-4370	

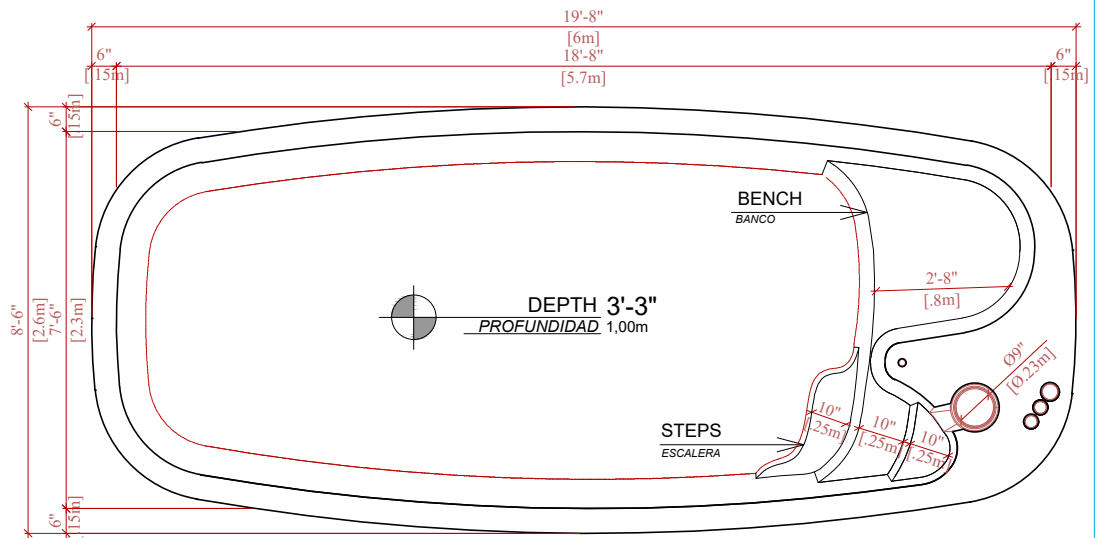

TECHNICAL DRAWING
DIBUJO TÉCNICO

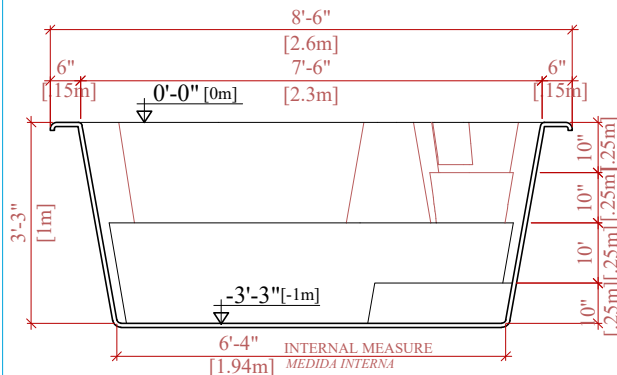

CROSS SECTION
CORTE TRANSVERSAL

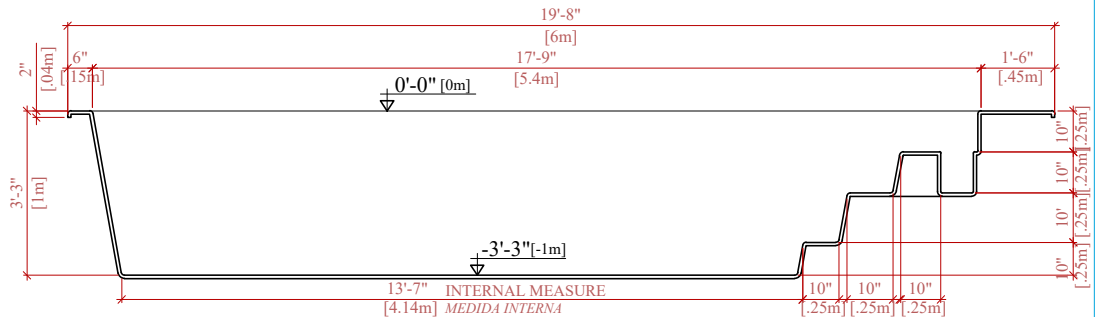

LONGITUDINAL SECTION
CORTE LONGITUDINAL