

SPECIFICATIONS		
SHELL WEIGHT PESO DE LA PISCINA	515,9 LBS.	234,0 Kg
WATER WEIGHT PESO DEL AGUA	43431,0 LBS.	19700,0 Kg
TOTAL WEIGHT PESO TOTAL	43946,9 LBS.	19934,0 Kg
WATER VOLUME VOLUMEN DE AGUA	695,7 Cu.Ft.	19,7 m ³
WATER GALLONS AND LITERS GALONES Y LITROS DE AGUA	5204,2 GAL.	19700,0 L
SURFACE AREA ÁREA DE SUPERFICIE	228,4 Sq. Ft.	21,2 m ²
ICC-ES LISTED# ICC-ES LISTADO	ESR-4370	

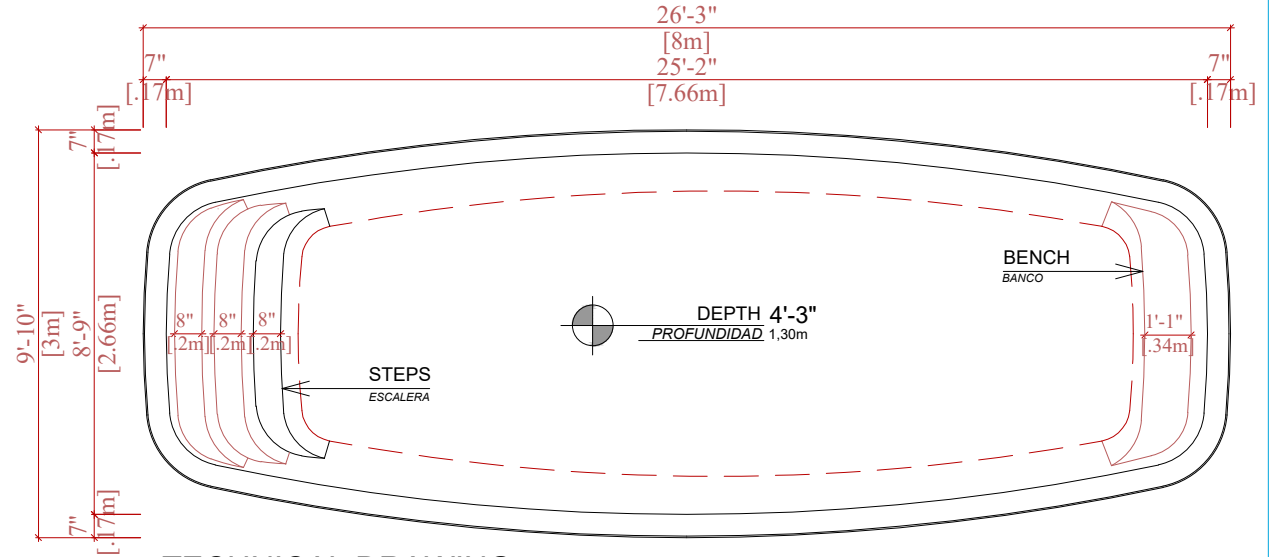

TECHNICAL DRAWING
DIBUJO TÉCNICO

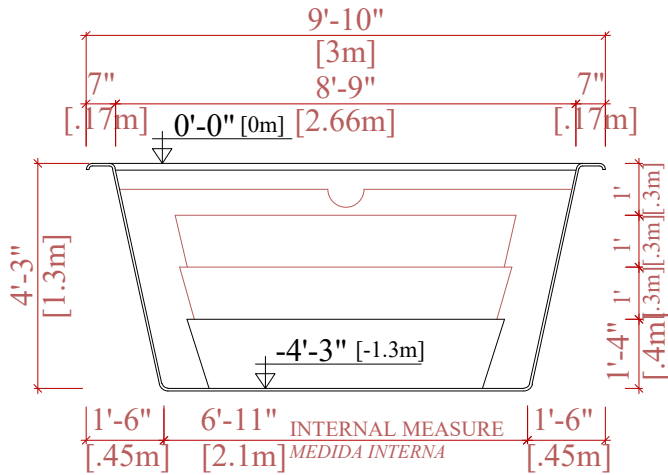

CROSS SECTION
CORTE TRANSVERSAL

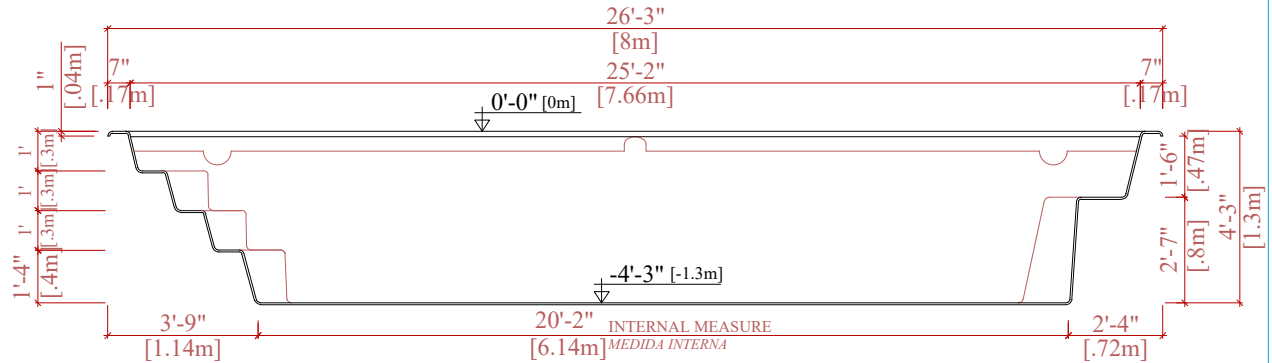

LONGITUDINAL SECTION
CORTE LONGITUDINAL