

SPECIFICATIONS		
SHELL WEIGHT PESO DE LA PISCINA	207,2 LBS.	94,0 Kg
WATER WEIGHT PESO DEL AGUA	9920,8 LBS.	4500,0 Kg
TOTAL WEIGHT PESO TOTAL	10128,0 LBS.	4594,0 Kg
WATER VOLUME VOLUMEN DE AGUA	158,9 Cu.Ft.	4,5 m ³
WATER GALLONS AND LITERS GALONES Y LITROS DE AGUA	1188,8 GAL.	4500,0 L
SURFACE AREA ÁREA DE SUPERFICIE	77,2 Sq. Ft.	7,2 m ²
ICC-ES LISTED# ICC-ES LISTADO	ESR-4370	

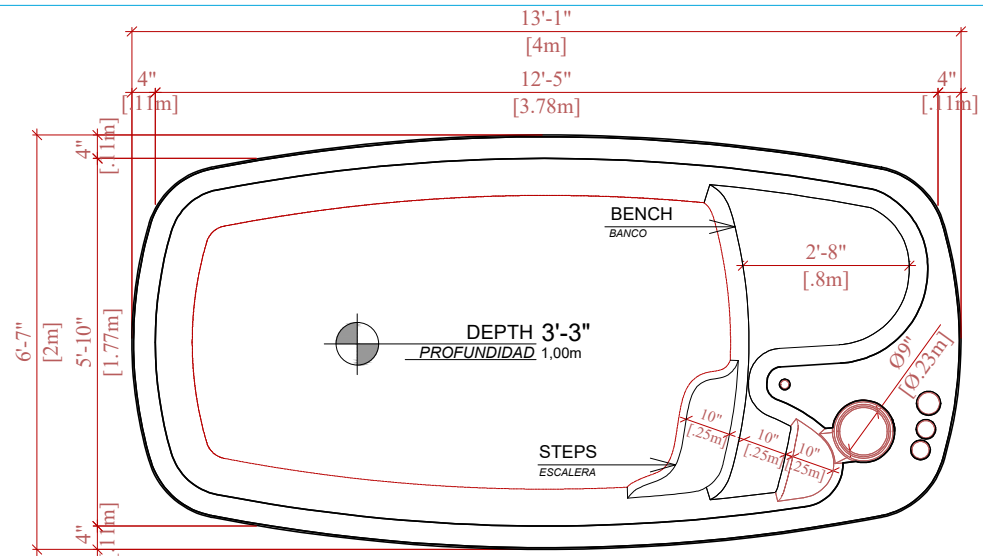

TECHNICAL DRAWING
DIBUJO TÉCNICO

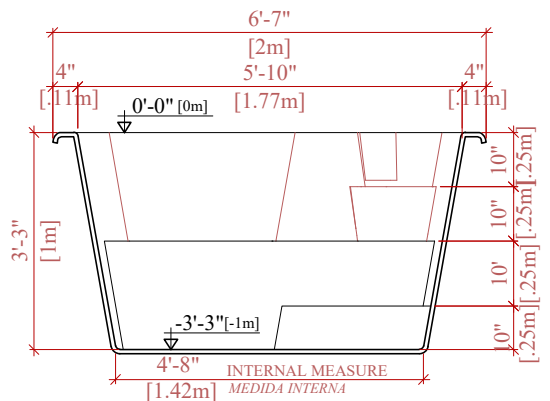

CROSS SECTION
CORTE TRANSVERSAL

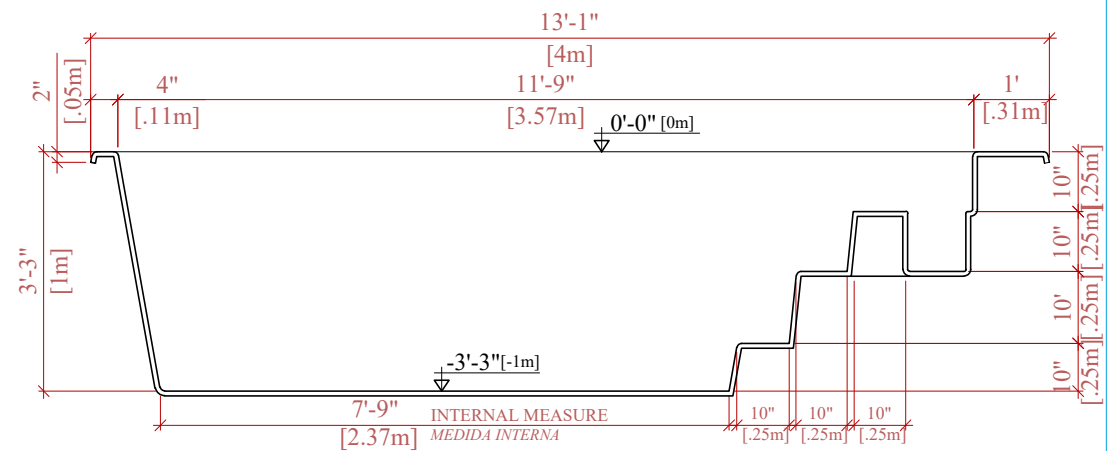

LONGITUDINAL SECTION
CORTE LONGITUDINAL