

SPECIFICATIONS		
SHELL WEIGHT PESO DE LA PISCINA	328,5 LBS.	149,0 Kg
WATER WEIGHT PESO DEL AGUA	28219,1 LBS.	12800,0 Kg
TOTAL WEIGHT PESO TOTAL	28547,6 LBS.	12949,0 Kg
WATER VOLUME VOLUMEN DE AGUA	452,0 Cu.Ft.	12,8 m ³
WATER GALLONS AND LITERS GALONES Y LITROS DE AGUA	3381,4 GAL.	12800,0 L
SURFACE AREA ÁREA DE SUPERFICIE	151,1 Sq. Ft.	14,0 m ²
ICC-ES LISTED# ICC-ES LISTADO	ESR-4370	

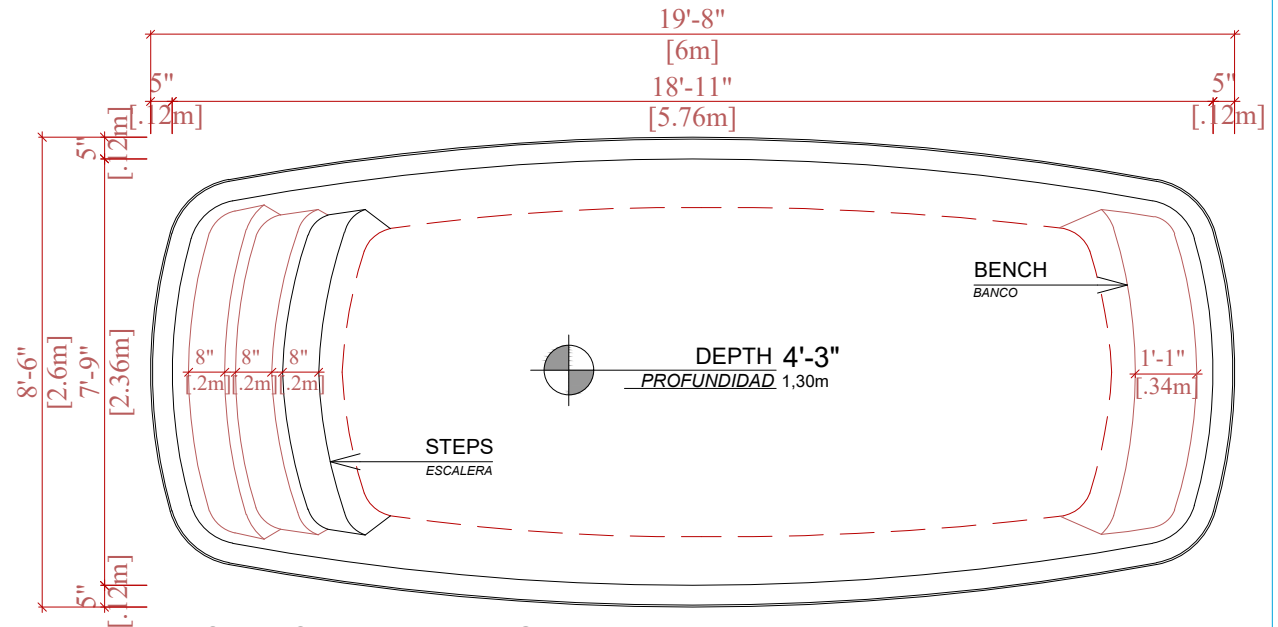

TECHNICAL DRAWING
DIBUJO TÉCNICO

